

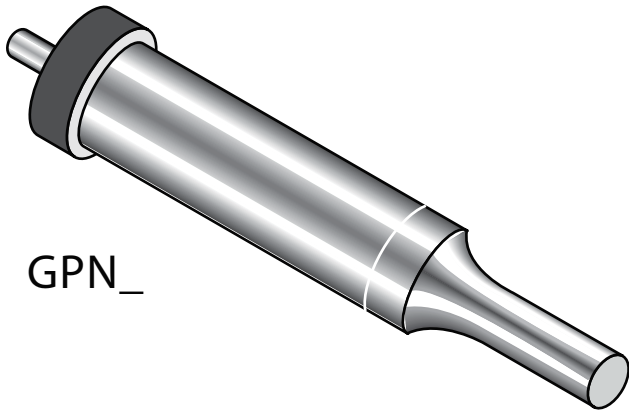

# General Punch Numerical

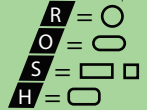

GPN\_

**Ordering Example:**  
(12) GPNR 13-13-71 A2 P10.1

**Ordering Example:**  
(12) GPNS 25-25-90 A2 P18.2 W9.9 K4

A2 R/c 60-63 double tempered

Heads drawn to Rc 40-55

Round P to D	0.01	
Shape P & W to D	0.02	

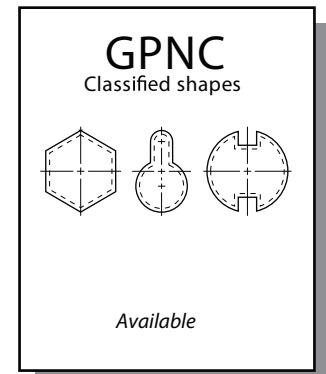
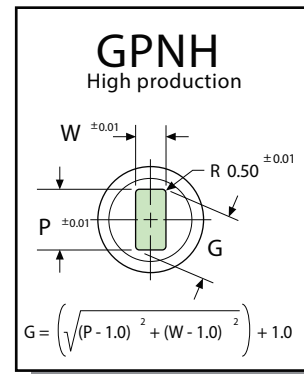
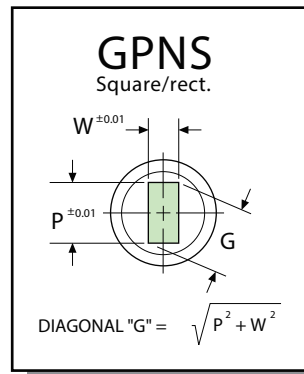
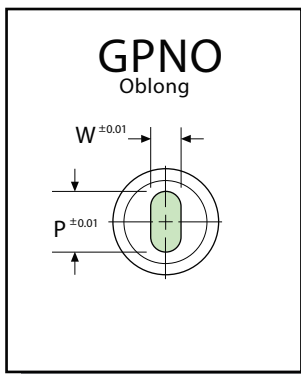
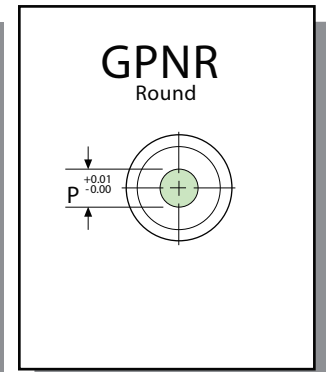
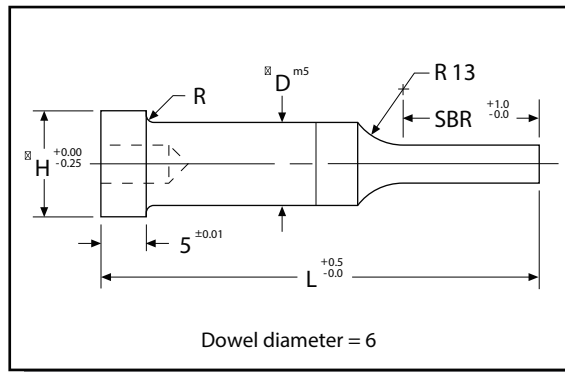
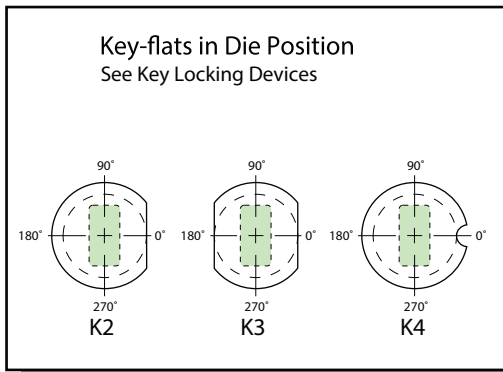

Type	"D"	Point Length "SBR"					Overall Length "L"				Round Min. "P"	Shape Min. "W"	Head Dia. "H"
		10	13	19	25	32	71	80	90	100			
GPN_	10	10	13	19			71	80	90	100	1.9	1.9	13
GPN_	13	10	13	19			71	80	90	100	3.1	3.1	16
GPN_	16		13	19	25		71	80	90	100	5.7	5.7	19
GPN_	20		13	19	25		71	80	90	100	5.7	5.7	24
GPN_	25		13	19	25		71	80	90	100	5.7	5.7	29
GPN_	32			19	25	32	71	80	90	100	5.7	5.7	36