

Rupture Disks



DME Industrial Supplies Line of Extruder Rupture Disks (Burst Plugs) are primarily used on Plastics Extrusion Machinery to provide emergency pressure relief. Extruder Rupture Disks from DME Industrial Supplies are designed to instantaneously rupture at a pre-determined pressure. Extruder Rupture Disks are leak tight and intrinsically safe devices that require no maintenance.

The Line of Extruder Rupture Disk assemblies are manufactured from 304 SS and incorporate either an Inconel or Stainless Steel Disk which minimize the affects of varying processing temperatures. The ERD Series of Extruder Rupture Disks from DME Industrial Supplies are offered in a wide variety of lengths and configurations. Standard stock assemblies are available in burst pressures ranging from 1,500 up to 15,000 psi, and lengths from 1.82" up to 12".

Several different mounting threads are offered on the Line of ERD Series Extruder Rupture Disks that are commonly found on plastics extrusion machinery.

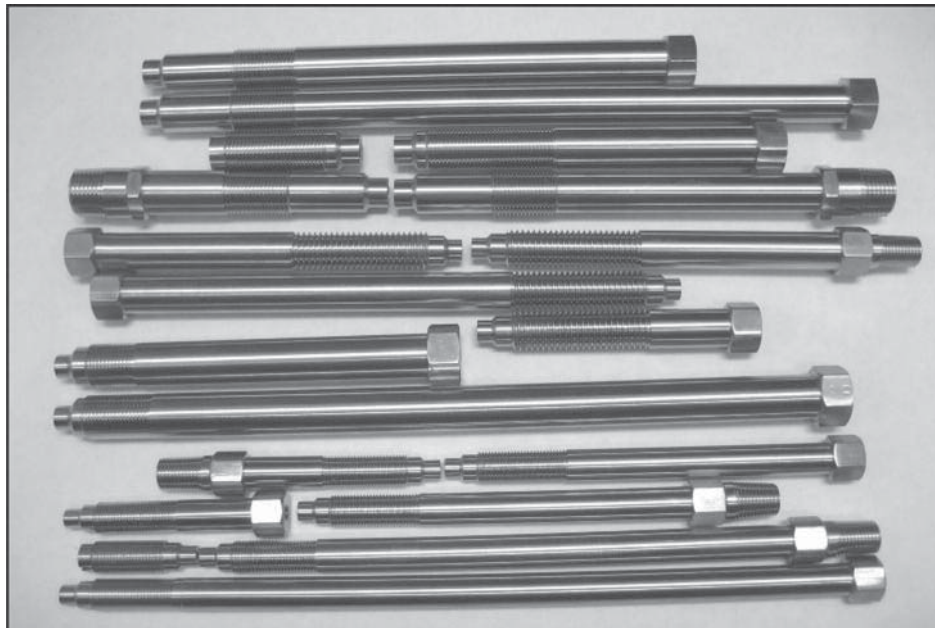

Rupture Disks

1/2" – 20 Mounting Thread

1.8" Length

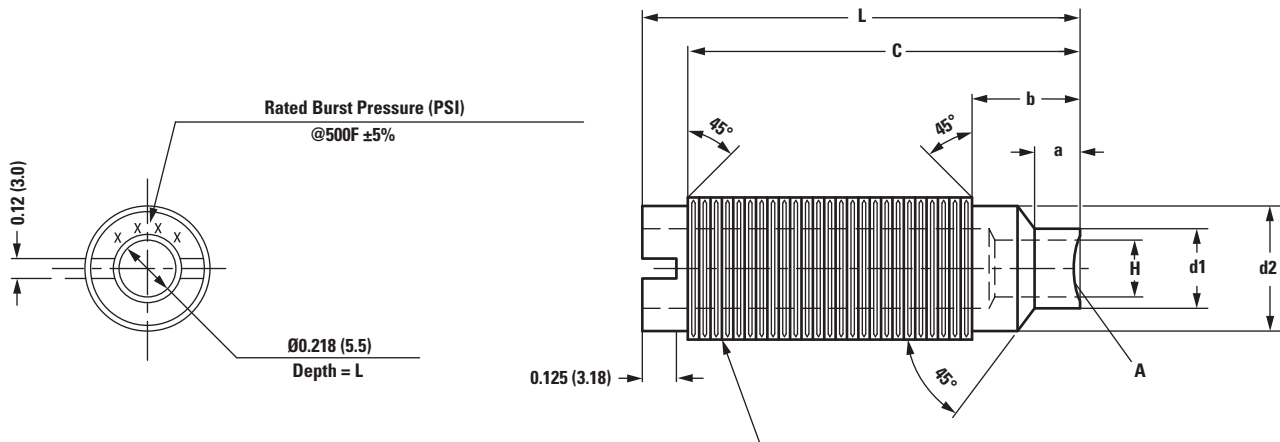

a	b	C	L
0.250 (6.35) 0.234 (5.94)	0.50 (12.7)	1.63 (41.40)	1.82 (46.2)

H	d1	d2
3/16" (4.76)	Ø0.310 (7.87) Ø0.305 (7.75)	Ø0.420 (10.67) Ø0.410 (10.41)

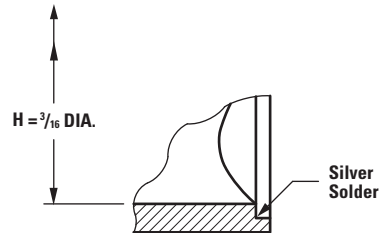

DETAIL A

Part Number	Mounting Thread	Length	Head Styles	Discharge Connection	Burst Pressure
ERD2-1.5M	1/2" 20 UNF	1.82"	Slotted	None	1,500
ERD2-2.5M	1/2" 20 UNF	1.82"	Slotted	None	2,500
ERD2-3.5M	1/2" 20 UNF	1.82"	Slotted	None	3,500
ERD2-4.5M	1/2" 20 UNF	1.82"	Slotted	None	4,500
ERD2-5.5M	1/2" 20 UNF	1.82"	Slotted	None	5,500
ERD2-6.5M	1/2" 20 UNF	1.82"	Slotted	None	6,500
ERD2-7.5M	1/2" 20 UNF	1.82"	Slotted	None	7,500
ERD2-8.5M	1/2" 20 UNF	1.82"	Slotted	None	8,500
ERD2-9.5M	1/2" 20 UNF	1.82"	Slotted	None	9,500
ERD2-10.5M	1/2" 20 UNF	1.82"	Slotted	None	10,500
ERD2-12.5M	1/2" 20 UNF	1.82"	Slotted	None	12,500
ERD2-15M	1/2" 20 UNF	1.82"	Slotted	None	15,000

Rupture Disks

1/2" – 20 Mounting Thread



3" Length

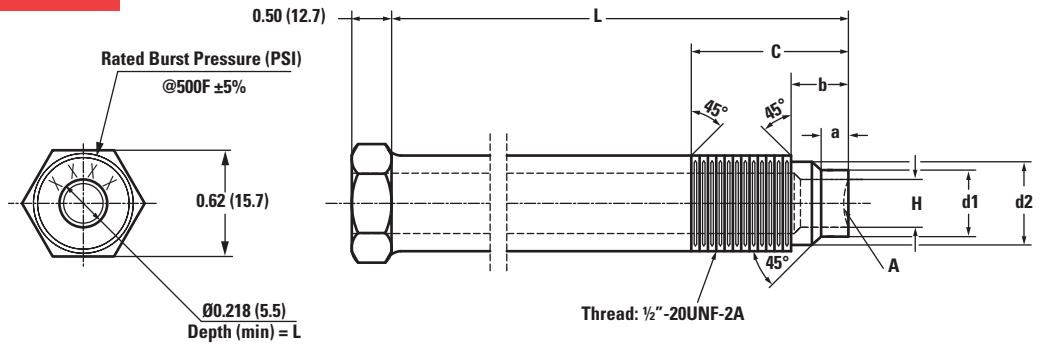

a	b	C	L
0.250 (6.35)	0.50 (12.7)	1.81 (45.97)	3.00 (76.2)
0.234 (5.94)			

H	d1	d2
3/16" (4.76)	ø0.310 (7.87)	ø0.420 (10.67)
	ø0.305 (7.75)	ø0.410 (10.41)

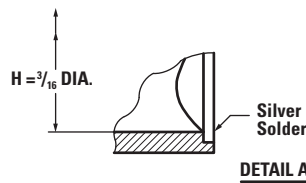

Part Number	Mounting Thread	Length	Head Styles	Discharge Connection	Burst Pressure
ERD3H1.5M	1/2" 20 UNF	3"	Hex	None	1,500
ERD3H2.5M	1/2" 20 UNF	3"	Hex	None	2,500
ERD3H3.5M	1/2" 20 UNF	3"	Hex	None	3,500
ERD3H4.5M	1/2" 20 UNF	3"	Hex	None	4,500
ERD3H5.5M	1/2" 20 UNF	3"	Hex	None	5,500
ERD3H6.5M	1/2" 20 UNF	3"	Hex	None	6,500
ERD3H7.5M	1/2" 20 UNF	3"	Hex	None	7,500
ERD3H8.5M	1/2" 20 UNF	3"	Hex	None	8,500
ERD3H9.5M	1/2" 20 UNF	3"	Hex	None	9,500
ERD3H10.5M	1/2" 20 UNF	3"	Hex	None	10,500
ERD3H12.5M	1/2" 20 UNF	3"	Hex	None	12,500
ERD3H15M	1/2" 20 UNF	3"	Hex	None	15,000
ERD3H1.5M14	1/2" 20 UNF	3"	Hex	1/4" NPT	1,500
ERD3H2.5M14	1/2" 20 UNF	3"	Hex	1/4" NPT	2,500
ERD3H3.5M14	1/2" 20 UNF	3"	Hex	1/4" NPT	3,500
ERD3H4.5M14	1/2" 20 UNF	3"	Hex	1/4" NPT	4,500
ERD3H5.5M14	1/2" 20 UNF	3"	Hex	1/4" NPT	5,500
ERD3H6.5M14	1/2" 20 UNF	3"	Hex	1/4" NPT	6,500
ERD3H7.5M14	1/2" 20 UNF	3"	Hex	1/4" NPT	7,500
ERD3H8.5M14	1/2" 20 UNF	3"	Hex	1/4" NPT	8,500
ERD3H9.5M14	1/2" 20 UNF	3"	Hex	1/4" NPT	9,500
ERD3H10.5M14	1/2" 20 UNF	3"	Hex	1/4" NPT	10,500
ERD3H12.5M14	1/2" 20 UNF	3"	Hex	1/4" NPT	12,500
ERD3H15M14	1/2" 20 UNF	3"	Hex	1/4" NPT	15,000

Rupture Disks

1/2" – 20 Mounting Thread

6" Length

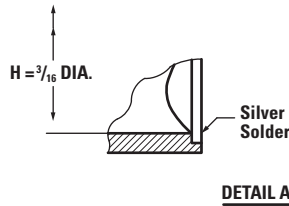
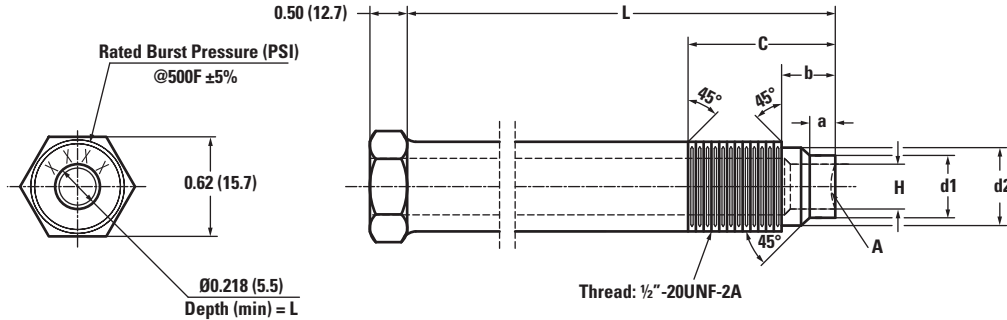

a	b	C	L
0.250 (6.35)	0.50 (12.7)	1.81 (45.97)	6.00 (152.4)
0.234 (5.94)			

H	d1	d2
3/16" (4.76)	ø0.310 (7.87)	ø0.420 (10.67)
	ø0.305 (7.75)	ø0.410 (10.41)

Part Number	Mounting Thread	Length	Head Styles	Discharge Connection	Burst Pressure
ERD6H1.5M	1/2" 20 UNF	6"	Hex	None	1,500
ERD6H2.5M	1/2" 20 UNF	6"	Hex	None	2,500
ERD6H3.5M	1/2" 20 UNF	6"	Hex	None	3,500
ERD6H4.5M	1/2" 20 UNF	6"	Hex	None	4,500
ERD6H5.5M	1/2" 20 UNF	6"	Hex	None	5,500
ERD6H6.5M	1/2" 20 UNF	6"	Hex	None	6,500
ERD6H7.5M	1/2" 20 UNF	6"	Hex	None	7,500
ERD6H8.5M	1/2" 20 UNF	6"	Hex	None	8,500
ERD6H9.5M	1/2" 20 UNF	6"	Hex	None	9,500
ERD6H10.5M	1/2" 20 UNF	6"	Hex	None	10,500
ERD6H12.5M	1/2" 20 UNF	6"	Hex	None	12,500
ERD6H15M	1/2" 20 UNF	6"	Hex	None	15,000
ERD6H1.5M14	1/2" 20 UNF	6"	Hex	1/4" NPT	1,500
ERD6H2.5M14	1/2" 20 UNF	6"	Hex	1/4" NPT	2,500
ERD6H3.5M14	1/2" 20 UNF	6"	Hex	1/4" NPT	3,500
ERD6H4.5M14	1/2" 20 UNF	6"	Hex	1/4" NPT	4,500
ERD6H5.5M14	1/2" 20 UNF	6"	Hex	1/4" NPT	5,500
ERD6H6.5M14	1/2" 20 UNF	6"	Hex	1/4" NPT	6,500
ERD6H7.5M14	1/2" 20 UNF	6"	Hex	1/4" NPT	7,500
ERD6H8.5M14	1/2" 20 UNF	6"	Hex	1/4" NPT	8,500
ERD6H9.5M14	1/2" 20 UNF	6"	Hex	1/4" NPT	9,500
ERD6H10.5M14	1/2" 20 UNF	6"	Hex	1/4" NPT	10,500
ERD6H12.5M14	1/2" 20 UNF	6"	Hex	1/4" NPT	12,500
ERD6H15M14	1/2" 20 UNF	6"	Hex	1/4" NPT	15,000

Rupture Disks

1/2" – 20 Mounting Thread



9" Length

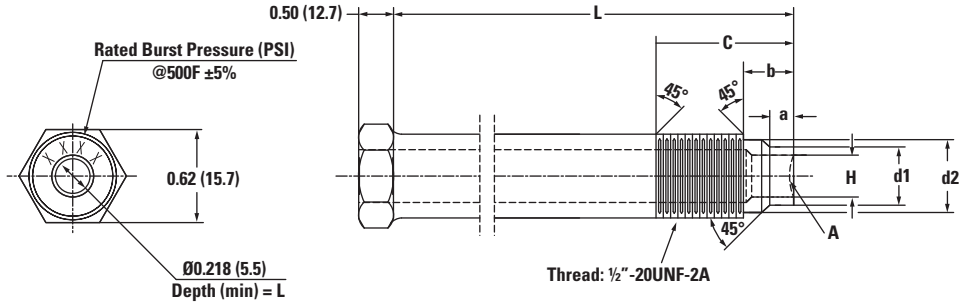

a	b	C	L
0.250 (6.35)	0.50 (12.7)	1.81 (45.97)	9.0 (228.6)
0.234 (5.94)			

H	d1	d2
3/16" (4.76)	ø0.310 (7.87)	ø0.420 (10.67)
	ø0.305 (7.75)	ø0.410 (10.41)

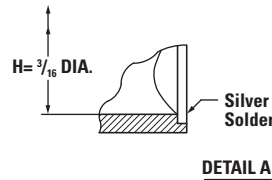

Part Number	Mounting Thread	Length	Head Styles	Discharge Connection	Burst Pressure
ERD9H1.5M	1/2" 20 UNF	9"	Hex	None	1,500
ERD9H2.5M	1/2" 20 UNF	9"	Hex	None	2,500
ERD9H3.5M	1/2" 20 UNF	9"	Hex	None	3,500
ERD9H4.5M	1/2" 20 UNF	9"	Hex	None	4,500
ERD9H5.5M	1/2" 20 UNF	9"	Hex	None	5,500
ERD9H6.5M	1/2" 20 UNF	9"	Hex	None	6,500
ERD9H7.5M	1/2" 20 UNF	9"	Hex	None	7,500
ERD9H8.5M	1/2" 20 UNF	9"	Hex	None	8,500
ERD9H9.5M	1/2" 20 UNF	9"	Hex	None	9,500
ERD9H10.5M	1/2" 20 UNF	9"	Hex	None	10,500
ERD9H12.5M	1/2" 20 UNF	9"	Hex	None	12,500
ERD9H15M	1/2" 20 UNF	9"	Hex	None	15,000
ERD9H1.5M14	1/2" 20 UNF	9"	Hex	1/4" NPT	1,500
ERD9H2.5M14	1/2" 20 UNF	9"	Hex	1/4" NPT	2,500
ERD9H3.5M14	1/2" 20 UNF	9"	Hex	1/4" NPT	3,500
ERD9H4.5M14	1/2" 20 UNF	9"	Hex	1/4" NPT	4,500
ERD9H5.5M14	1/2" 20 UNF	9"	Hex	1/4" NPT	5,500
ERD9H6.5M14	1/2" 20 UNF	9"	Hex	1/4" NPT	6,500
ERD9H7.5M14	1/2" 20 UNF	9"	Hex	1/4" NPT	7,500
ERD9H8.5M14	1/2" 20 UNF	9"	Hex	1/4" NPT	8,500
ERD9H9.5M14	1/2" 20 UNF	9"	Hex	1/4" NPT	9,500
ERD9H10.5M14	1/2" 20 UNF	9"	Hex	1/4" NPT	10,500
ERD9H12.5M14	1/2" 20 UNF	9"	Hex	1/4" NPT	12,500
ERD9H15M14	1/2" 20 UNF	9"	Hex	1/4" NPT	15,000

Rupture Disks

1/2" – 20 Mounting Thread

12" Length

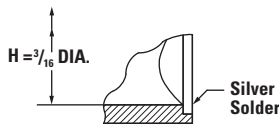
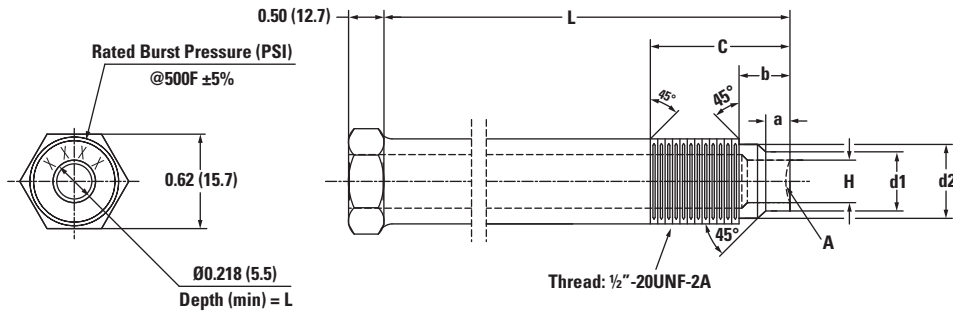

DETAIL A

a	b	C	L
0.250 (6.35)	0.50 (12.7)	1.81 (45.97)	12.0 (304.8)
0.234 (5.94)			

H	d1	d2
3/16" (4.76)	ø0.310 (7.87)	ø0.420 (10.67)
	ø0.305 (7.75)	ø0.410 (10.41)

Part Number	Mounting Thread	Length	Head Styles	Discharge Connection	Burst Pressure
ERD12H1.5M	1/2" 20 UNF	12"	Hex	None	1,500
ERD12H2.5M	1/2" 20 UNF	12"	Hex	None	2,500
ERD12H3.5M	1/2" 20 UNF	12"	Hex	None	3,500
ERD12H4.5M	1/2" 20 UNF	12"	Hex	None	4,500
ERD12H5.5M	1/2" 20 UNF	12"	Hex	None	5,500
ERD12H6.5M	1/2" 20 UNF	12"	Hex	None	6,500
ERD12H7.5M	1/2" 20 UNF	12"	Hex	None	7,500
ERD12H8.5M	1/2" 20 UNF	12"	Hex	None	8,500
ERD12H9.5M	1/2" 20 UNF	12"	Hex	None	9,500
ERD12H10.5M	1/2" 20 UNF	12"	Hex	None	10,500
ERD12H12.5M	1/2" 20 UNF	12"	Hex	None	12,500
ERD12H15M	1/2" 20 UNF	12"	Hex	None	15,000
ERD12H1.5M14	1/2" 20 UNF	12"	Hex	1/4" NPT	1,500
ERD12H2.5M14	1/2" 20 UNF	12"	Hex	1/4" NPT	2,500
ERD12H3.5M14	1/2" 20 UNF	12"	Hex	1/4" NPT	3,500
ERD12H4.5M14	1/2" 20 UNF	12"	Hex	1/4" NPT	4,500
ERD12H5.5M14	1/2" 20 UNF	12"	Hex	1/4" NPT	5,500
ERD12H6.5M14	1/2" 20 UNF	12"	Hex	1/4" NPT	6,500
ERD12H7.5M14	1/2" 20 UNF	12"	Hex	1/4" NPT	7,500
ERD12H8.5M14	1/2" 20 UNF	12"	Hex	1/4" NPT	8,500
ERD12H9.5M14	1/2" 20 UNF	12"	Hex	1/4" NPT	9,500
ERD12H10.5M14	1/2" 20 UNF	12"	Hex	1/4" NPT	10,500
ERD12H12.5M14	1/2" 20 UNF	12"	Hex	1/4" NPT	12,500
ERD12H15M14	1/2" 20 UNF	12"	Hex	1/4" NPT	15,000

Rupture Disks

3/4" – 16 Mounting Thread



2 1/2" & 4" Length

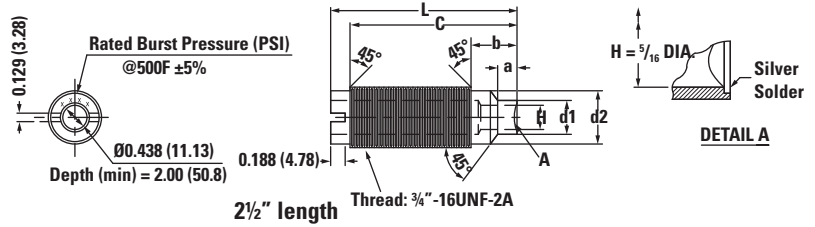

a	b	C	L
0.312 (7.93)	0.545 (13.84)	2.25 (57.15)	2.50 (63.5)
0.300 (7.62)			
H	d1	d2	
5/16" (7.95)	ø0.500 (12.70)	ø0.665 (16.89)	
	ø0.495 (12.57)	ø0.655 (16.64)	

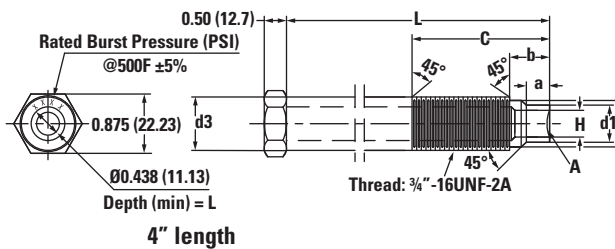
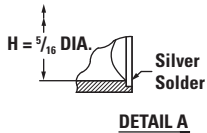

a	b	C	L
0.300 (7.62)	0.545 (13.84)	2.70 (68.58)	4.00 (101.6)
0.312 (7.93)			
H	d1	d2	d3
5/16" (7.95)	ø0.500 (12.70)	ø0.665 (16.89)	ø0.66 (16.76)
	ø0.495 (12.57)	ø0.655 (16.64)	

Part Number	Mounting Thread	Length	Head Styles	Discharge Connection	Burst Pressure
ERD2-34-3.5M	3/4" 16 UNF	2-1/2"	Slotted	None	3,500
ERD2-34-4.5M	3/4" 16 UNF	2-1/2"	Slotted	None	4,500
ERD2-34-5M	3/4" 16 UNF	2-1/2"	Slotted	None	5,000
ERD2-34-7.5M	3/4" 16 UNF	2-1/2"	Slotted	None	7,500
ERD2-34-8.5M	3/4" 16 UNF	2-1/2"	Slotted	None	8,500
ERD2-34-9M	3/4" 16 UNF	2-1/2"	Slotted	None	9,000
ERD2-34-9.5M	3/4" 16 UNF	2-1/2"	Slotted	None	9,500
ERD4H34-3.5M	3/4" 16 UNF	4"	Hex	None	3,500
ERD4H34-4.5M	3/4" 16 UNF	4"	Hex	None	4,500
ERD4H34-5M	3/4" 16 UNF	4"	Hex	None	5,000
ERD4H34-7.5M	3/4" 16 UNF	4"	Hex	None	7,500
ERD4H34-8.5M	3/4" 16 UNF	4"	Hex	None	8,500
ERD4H34-9M	3/4" 16 UNF	4"	Hex	None	9,000
ERD4H34-9.5M	3/4" 16 UNF	4"	Hex	None	9,500
ERD4H34-3.5M12	3/4" 16 UNF	4"	Hex	1/2" NPT	3,500
ERD4H34-4.5M12	3/4" 16 UNF	4"	Hex	1/2" NPT	4,500
ERD4H34-5M12	3/4" 16 UNF	4"	Hex	1/2" NPT	5,000
ERD4H34-7.5M12	3/4" 16 UNF	4"	Hex	1/2" NPT	7,500
ERD4H34-8.5M12	3/4" 16 UNF	4"	Hex	1/2" NPT	8,500
ERD4H34-9M12	3/4" 16 UNF	4"	Hex	1/2" NPT	9,000
ERD4H34-9.5M12	3/4" 16 UNF	4"	Hex	1/2" NPT	9,500
ERD4H34S3.5M12	3/4" 16 UNF Short Thread	4"	Hex	1/2" NPT	3,500
ERD4H34S4.5M12		4"	Hex	1/2" NPT	4,500
ERD4H34S5M12		4"	Hex	1/2" NPT	5,000
ERD4H34S7.5M12		4"	Hex	1/2" NPT	7,500
ERD4H34S8.5M12		4"	Hex	1/2" NPT	8,500
ERD4H34S9M12		4"	Hex	1/2" NPT	9,000
ERD4H34S9.5M12		4"	Hex	1/2" NPT	9,500

Rupture Disks

3/4" – 16 Mounting Thread

6" & 7" Length

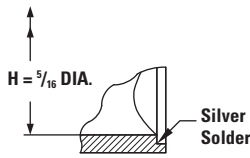
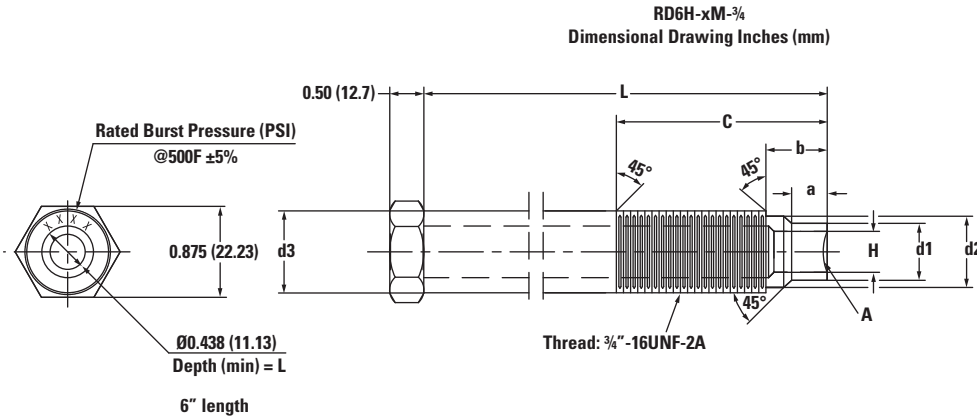

DETAIL A

a	b	C	L
0.300 (7.62)	0.545 (13.84)	2.70 (68.58)	6.00 (152.4)
0.312 (7.93)			

H	d1	d2	d3
5/16" (7.95)	Ø0.500 (12.70) Ø0.495 (12.57)	Ø0.665 (16.89) Ø0.655 (16.64)	Ø0.66 (16.76)

Part Number	Mounting Thread	Length	Head Styles	Discharge Connection	Burst Pressure
ERD6H34-3.5M	3/4" 16 UNF	6"	Hex	None	3,500
ERD6H34-4.5M	3/4" 16 UNF	6"	Hex	None	4,500
ERD6H34-5M	3/4" 16 UNF	6"	Hex	None	5,000
ERD6H34-7.5M	3/4" 16 UNF	6"	Hex	None	7,500
ERD6H34-8.5M	3/4" 16 UNF	6"	Hex	None	8,500
ERD6H34-9M	3/4" 16 UNF	6"	Hex	None	9,000
ERD6H34-9.5M	3/4" 16 UNF	6"	Hex	None	9,500
ERD7H34-3.5M12	3/4" 16 UNF	7"	Hex	1/2" NPT	3,500
ERD7H34-4.5M12	3/4" 16 UNF	7"	Hex	1/2" NPT	4,500
ERD7H34-5M12	3/4" 16 UNF	7"	Hex	1/2" NPT	5,000
ERD7H34-7.5M12	3/4" 16 UNF	7"	Hex	1/2" NPT	7,500
ERD7H34-8.5M12	3/4" 16 UNF	7"	Hex	1/2" NPT	8,500
ERD7H34-9M12	3/4" 16 UNF	7"	Hex	1/2" NPT	9,000
ERD7H34-9.5M12	3/4" 16 UNF	7"	Hex	1/2" NPT	9,500
ERD7H34S3.5M12	3/4" 16 UNF Short Thread	7"	Hex	1/2" NPT	3,500
ERD7H34S4.5M12		7"	Hex	1/2" NPT	4,500
ERD7H34S5M12		7"	Hex	1/2" NPT	5,000
ERD7H34S7.5M12		7"	Hex	1/2" NPT	7,500
ERD7H34S8.5M12		7"	Hex	1/2" NPT	8,500
ERD7H34S9M12		7"	Hex	1/2" NPT	9,000
ERD7H34S9.5M12		7"	Hex	1/2" NPT	9,500

Rupture Disks

3/4" – 16 Mounting Thread



9" & 12" Length

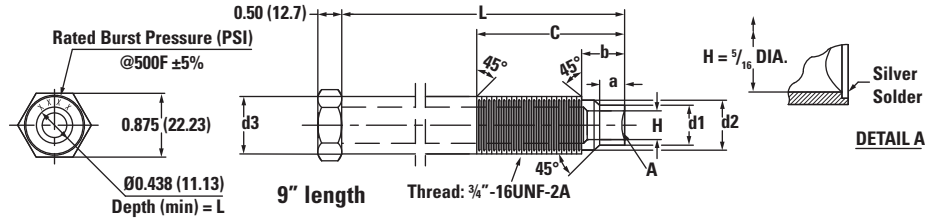

a	b	C	L
0.300 (7.62)	0.545 (13.84)	2.70 (68.58)	9.00 (228.6)
0.312 (7.93)			

H	d1	d2	d3
5/16" (7.95)	ø0.500 (12.70)	ø0.665 (16.89)	ø0.66 (16.76)
	ø0.495 (12.57)	ø0.655 (16.64)	

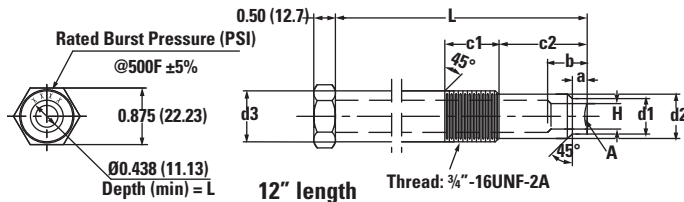
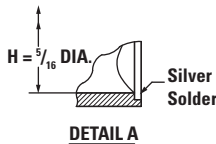

a	b	c1	c2	L
0.300 (7.62)	0.545 (13.84)	1.10 (27.94)	1.60 (40.64)	12.00 (304.8)
0.312 (7.93)				

H	d1	d2	d3
5/16" (7.95)	ø0.50 (12.70)	ø0.665 (16.89)	ø0.66 (16.76)
	ø0.495 (12.57)	ø0.655 (16.64)	

Part Number	Mounting Thread	Length	Head Styles	Discharge Connection	Burst Pressure
ERD9H34S3.5M	3/4" 16 UNF Short Thread	9"	Hex	None	3,500
ERD9H34S4.5M		9"	Hex	None	4,500
ERD9H34S5M		9"	Hex	None	5,000
ERD9H34S7.5M		9"	Hex	None	7,500
ERD9H34S8.5M		9"	Hex	None	8,500
ERD9H34S9M		9"	Hex	None	9,000
ERD9H34S9.5M		9"	Hex	None	9,500
ERD12H34S3.5M	3/4" 16 UNF Short Thread	12"	Hex	None	3,500
ERD12H34S4.5M		12"	Hex	None	4,500
ERD12H34S5M		12"	Hex	None	5,000
ERD12H34S7.5M		12"	Hex	None	7,500
ERD12H34S8.5M		12"	Hex	None	8,500
ERD12H34S9M		12"	Hex	None	9,000
ERD12H34S9.5M		12"	Hex	None	9,500



Rupture Disks

5/8" – 11 Mounting Thread

4" & 6" Length

Part Number	Mounting Thread	Length	Head Styles	Discharge Connection	Burst Pressure
ERD4H58-1.5M	5/8" 11 NC	4"	Hex	None	1,500
ERD4H58-2.5M	5/8" 11 NC	4"	Hex	None	2,500
ERD4H58-3.5M	5/8" 11 NC	4"	Hex	None	3,500
ERD4H58-4.5M	5/8" 11 NC	4"	Hex	None	4,500
ERD4H58-5.5M	5/8" 11 NC	4"	Hex	None	5,500
ERD4H58-6.5M	5/8" 11 NC	4"	Hex	None	6,500
ERD4H58-7.5M	5/8" 11 NC	4"	Hex	None	7,600
ERD4H58-8.5M	5/8" 11 NC	4"	Hex	None	8,500
ERD4H58-9.5M	5/8" 11 NC	4"	Hex	None	9,500
ERD4H58-10.5M	5/8" 11 NC	4"	Hex	None	10,500
ERD4H58-12.5M	5/8" 11 NC	4"	Hex	None	12,500
ERD4H58-15M	5/8" 11 NC	4"	Hex	None	15,000
ERD6H58-1.5M	5/8" 11 NC	6"	Hex	None	1,500
ERD6H58-2.5M	5/8" 11 NC	6"	Hex	None	2,500
ERD6H58-3.5M	5/8" 11 NC	6"	Hex	None	3,500
ERD6H58-4.5M	5/8" 11 NC	6"	Hex	None	4,500
ERD6H58-5.5M	5/8" 11 NC	6"	Hex	None	5,500
ERD6H58-6.5M	5/8" 11 NC	6"	Hex	None	6,500
ERD6H58-7.5M	5/8" 11 NC	6"	Hex	None	7,600
ERD6H58-8.5M	5/8" 11 NC	6"	Hex	None	8,500
ERD6H58-9.5M	5/8" 11 NC	6"	Hex	None	9,500
ERD6H58-10.5M	5/8" 11 NC	6"	Hex	None	10,500
ERD6H58-12.5M	5/8" 11 NC	6"	Hex	None	12,500
ERD6H58-15M	5/8" 11 NC	6"	Hex	None	15,000
ERD6H58-1.5M14	5/8" 11 NC	6"	Hex	1/4" NPT	1,500
ERD6H58-2.5M14	5/8" 11 NC	6"	Hex	1/4" NPT	2,500
ERD6H58-3.5M14	5/8" 11 NC	6"	Hex	1/4" NPT	3,500
ERD6H58-4.5M14	5/8" 11 NC	6"	Hex	1/4" NPT	4,500
ERD6H58-5.5M14	5/8" 11 NC	6"	Hex	1/4" NPT	5,500
ERD6H58-6.5M14	5/8" 11 NC	6"	Hex	1/4" NPT	6,500
ERD6H58-7.5M14	5/8" 11 NC	6"	Hex	1/4" NPT	7,600
ERD6H58-8.5M14	5/8" 11 NC	6"	Hex	1/4" NPT	8,500
ERD6H58-9.5M14	5/8" 11 NC	6"	Hex	1/4" NPT	9,500
ERD6H58-10.5M14	5/8" 11 NC	6"	Hex	1/4" NPT	10,500
ERD6H58-12.5M14	5/8" 11 NC	6"	Hex	1/4" NPT	12,500
ERD6H58-15M14	5/8" 11 NC	6"	Hex	1/4" NPT	15,000

*Note: No 4" length drawing currently unavailable.

Rupture Disks

$\frac{5}{8}$ " – 11 Mounting Thread



9" Length

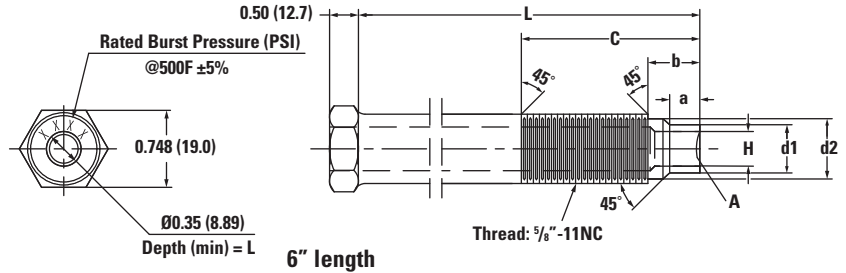

a	b	C	L
0.238 (6.05)	0.554 (14.07)	2.75 (69.85)	6.00 (152.4)

H	d1	d2
$\frac{3}{16}$ " (4.78)	0.354 (8.99)	0.488 (12.40)

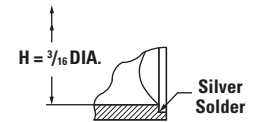

DETAIL A

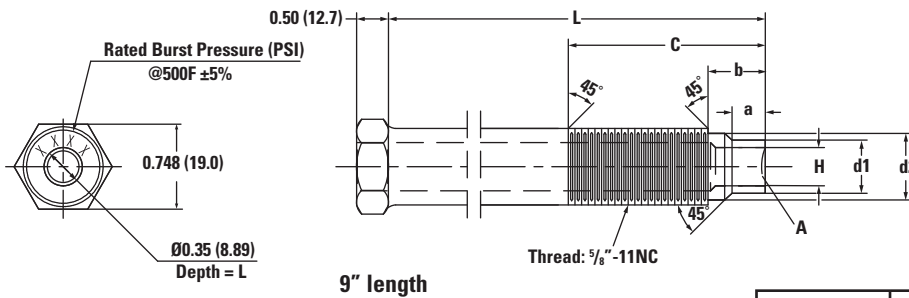

a	b	C	L
0.238 (6.05)	0.554 (14.07)	2.75 (69.85)	9.00 (228.6)

H	d1	d2
$\frac{3}{16}$ " (4.78)	0.354 (8.99)	0.488 (12.40)

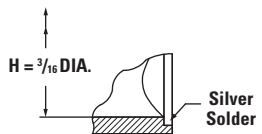

DETAIL A

Part Number	Mounting Thread	Length	Head Styles	Discharge Connection	Burst Pressure
ERD9H58-1.5M	$\frac{5}{8}$ " 11 NC	9"	Hex	None	1,500
ERD9H58-2.5M	$\frac{5}{8}$ " 11 NC	9"	Hex	None	2,500
ERD9H58-3.5M	$\frac{5}{8}$ " 11 NC	9"	Hex	None	3,500
ERD9H58-4.5M	$\frac{5}{8}$ " 11 NC	9"	Hex	None	4,500
ERD9H58-5.5M	$\frac{5}{8}$ " 11 NC	9"	Hex	None	5,500
ERD9H58-6.5M	$\frac{5}{8}$ " 11 NC	9"	Hex	None	6,500
ERD9H58-7.5M	$\frac{5}{8}$ " 11 NC	9"	Hex	None	7,600
ERD9H58-8.5M	$\frac{5}{8}$ " 11 NC	9"	Hex	None	8,500
ERD9H58-9.5M	$\frac{5}{8}$ " 11 NC	9"	Hex	None	9,500
ERD9H58-10.5M	$\frac{5}{8}$ " 11 NC	9"	Hex	None	10,500
ERD9H58-12.5M	$\frac{5}{8}$ " 11 NC	9"	Hex	None	12,500
ERD9H58-15M	$\frac{5}{8}$ " 11 NC	9"	Hex	None	15,000

Rupture Disks

M18 x 1.5 Mounting Thread

6" & 12" Length

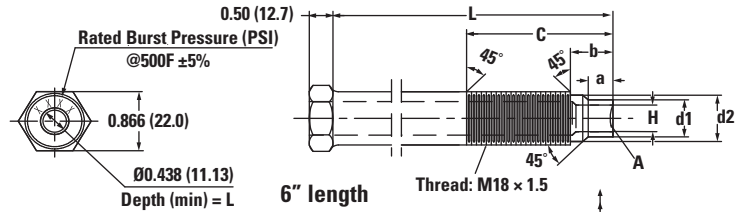

a	b	C	L
0.250 (6.35)	0.50 (12.7)	1.63 (41.40)	6.00 (152.4)
0.234 (5.94)			

H	d1	d2
3/16" (4.78)	ø0.397 (10.08)	ø0.632 (16.05)
	ø0.392 (9.96)	ø0.627 (15.93)

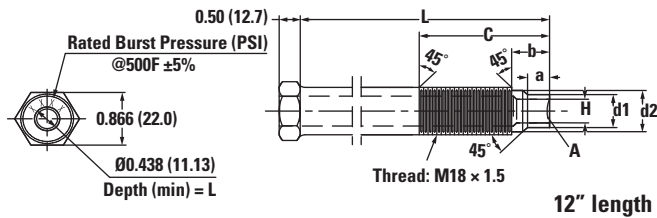
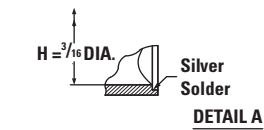
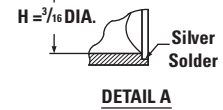

a	b	C	L
0.250 (6.35)	0.50 (12.7)	1.63 (41.40)	12.00 (304.8)
0.234 (5.94)			

H	d1	d2
3/16" (4.78)	ø0.397 (10.08)	ø0.632 (16.05)
	ø0.392 (9.96)	ø0.627 (15.93)

Part Number	Mounting Thread	Length	Head Styles	Discharge Connection	Burst Pressure
ERD6HM18-1.5M	M18 x 1.5	6"	Hex	None	1,500
ERD6HM18-2.5M	M18 x 1.5	6"	Hex	None	2,500
ERD6HM18-3.5M	M18 x 1.5	6"	Hex	None	3,500
ERD6HM18-4.5M	M18 x 1.5	6"	Hex	None	4,500
ERD6HM18-5.5M	M18 x 1.5	6"	Hex	None	5,500
ERD6HM18-6.5M	M18 x 1.5	6"	Hex	None	6,500
ERD6HM18-7.5M	M18 x 1.5	6"	Hex	None	7,600
ERD6HM18-8.5M	M18 x 1.5	6"	Hex	None	8,500
ERD6HM18-9.5M	M18 x 1.5	6"	Hex	None	9,500
ERD6HM18-10.5M	M18 x 1.5	6"	Hex	None	10,500
ERD6HM18-12.5M	M18 x 1.5	6"	Hex	None	12,500
ERD6HM18-15M	M18 x 1.5	6"	Hex	None	15,000
ERD12HM18-1.5M	M18 x 1.5	12"	Hex	None	1,500
ERD12HM18-2.5M	M18 x 1.5	12"	Hex	None	2,500
ERD12HM18-3.5M	M18 x 1.5	12"	Hex	None	3,500
ERD12HM18-4.5M	M18 x 1.5	12"	Hex	None	4,500
ERD12HM18-5.5M	M18 x 1.5	12"	Hex	None	5,500
ERD12HM18-6.5M	M18 x 1.5	12"	Hex	None	6,500
ERD12HM18-7.5M	M18 x 1.5	12"	Hex	None	7,600
ERD12HM18-8.5M	M18 x 1.5	12"	Hex	None	8,500
ERD12HM18-9.5M	M18 x 1.5	12"	Hex	None	9,500
ERD12HM18-10.5M	M18 x 1.5	12"	Hex	None	10,500
ERD12HM18-12.5M	M18 x 1.5	12"	Hex	None	12,500
ERD12HM18-15M	M18 x 1.5	12"	Hex	None	15,000