

Ultraform®

The D-M-E Ultraform® Ultrasonic Finishing and Polishing Systems are designed to replace costly, time-consuming hand finishing operations. They excel at rapid deburring, filing, stoning, polishing and lapping on a variety of surfaces, including EDM, tungsten carbide, mold steels and more.

Using a continuously variable stroke of 4 to 40 microns (.00016 to .0016 inches) and ultrasonic vibrations of 20,000 cycles per second, these systems provide the ideal combination of pin-point control and heavy duty power. There is no need to adjust or "tune-in" the ultrasonic frequency for various replaceable tools. The Ultraform units automatically adjust the proper frequency for all size tools, including diamond files up to 6 inches long.

Two types of ultrasonic modules are available to fit your specific finishing needs. Select the UF-2600, a single function ultrasonic polisher, or the UF-5600, a dual system offering both Ultrasonic and Minitor functions which must be used independently.



Both the UF-2600 and UF-5600 systems include a universal hand piece that can be used with both large and small tooling. Each system is supplied with a variety of tools and all of the necessary accessories to handle your most intricate polishing jobs with ease.

IMPROVED FEATURES

D-M-E's Ultraform models UF-2600 and UF-5600 offer the following improvements over previous systems:

- Added power increases tool cutting strength by 50%
- Improved circuitry provides constant power, regardless of the amount of pressure applied to the handpiece
- New transformer improves reliability
- Cool, vibration-free handpiece can be used with small and large tooling
- Clamp tool mode reduces power by 50%, preventing broken stones and burnt wood laps
- Power packs feature new updated cabinet styling and control panel layout
- UF-5600 model has 30% more torque when using rotary handpieces
- Universal handpiece is included with each system

HANDPIECE UF-9700

Universal handpiece can be used with either system for large and small tooling. The UF-9700 has a tool holder thread of 6mm, rather than the 8mm thread offered on previous handpieces. The handpiece and a 6-to-4mm adapter are included with both systems. All 8mm tooling will be replaced with 6mm to accommodate the new handpiece.



ULTRAFORM UF-5600

Dual Operating Capabilities – Ultrasonic and Minitor functions.

Automatic Frequency Shift – Accommodates a broad range of tool sizes.

Tool Condition – The UF-5600 calculates resonant frequencies and enables the operator to make customized tools. Reset switch activates if tool is too long or short.

Reversing Switch – Reverses rotation of handpiece for exact polishing of edges, corners, radii, etc.

State-of-the-art Circuitry – Improves torque at any RPM setting.

LED-Indicator Lights – Monitor power conditions and indicate operational modes.

User-Friendly Key Pad – Puts all functions within easy reach of operator.

ULTRAFORM UF-2600

Single Function Ultrasonic Polisher – Permits rapid deburring, filing, stoning, polishing and lapping with minimal operator effort.

Self-tuning Frequency Adjustment – Simplifies operation.

LED-Indicator Lights – Monitor power conditions and indicate operational modes.

User-Friendly Key Pad – Puts all functions within easy reach of operator.

Portable – Lightweight case with built-in carrying handle makes the unit easy to carry.

Ultraform®



STANDARD TOOLS AND ACCESSORIES INCLUDED WITH UF-2600 AND UF-5600:

- | | | | |
|-------------------------------|----------------------------------|-------------------------------|--|
| 4 diamond files | 5 tool clamps | 1 allen key | 1 plastic toolbox |
| 3 resin bonded diamond stones | 1 adapter – 6mm to 4mm thread | 1 replacement fuse | 2 protective sleeves for the handpiece |
| 2 ea. of 6 ceramic stones | 1 ultrasonic handpiece | 1 power cord | 1 wooden case for the handpiece |
| 2 wooden laps | 4 wrenches: 8mm, (2) 10mm & 12mm | 1 handpiece rest | 1 power cord |
| 3 diamond stones | | 1 set of protective ear plugs | |

ITEM NUMBER	DESCRIPTION
UF-2600	Power Module UF-2600 and all standard tools and accessories
UF-5600	Power Module UF-5600 and all standard tools and accessories
UF-9700	Handpiece for UF-2600 and UF-5600 (included)
UF-7503	Memory Foot Switch (optional)

NOTE: If ordering other than standard 120 voltage, please specify.
 Ultrasonic Handpiece UF-9700 is included with UF-2600 and UF-5600 Ultraform Systems.

POWER MODULE SPECIFICATIONS		
Model	UF-2600 and UF-5600	
Frequency of vibration	20.0 – 30.0 KHz	
Amplitude (stroke)	4 to 40 microns (.00016 to .0016")	
Frequency adjustment	Automatic feedback system	
Power output ultrasonic	45 watts max.	
Minitor power output (UF-5600 only)	DC 0 – 30 volts	
Output adjustment (power and stroke)	Continuously variable	
Power requirement	Single phase 100 to 250 v 50/60 Hz	
	UF-2600	UF-5600
Power consumption	100 VA	200 VA
Fuse	1.5 amperes 115 v 1 amperes 220 v	2 amperes 115 v 1.5 amperes 220 v
Outside dimension	7.1 × 8.4 × 6.2 inches	6.5 × 11.2 × 8.4 in.
Net weight	5.3 lbs.	8.2 lbs.

HANDPIECE UF-9700 SPECIFICATIONS	
Transducer	B.L.T. electrostrictive
Cable length	2 feet (coiled)
Screw thread	6 and 4mm with adapter
Dimensions	Small dia. 0.6" Large dia. 1.12" Length 5.12"
Weight	4.55 ounces

ADDITIONAL TOOLING:

Additional tooling for the Ultraform Ultrasonic Finishing and Polishing System is available.

Refer to D-M-E's ULTRAFORM ULTRASONIC TOOLING items for details.



MEMORY FOOT SWITCH UF-7503

With the Memory Foot Switch power can be increased, decreased or memorized with a simple touch of the foot. Foot control can be used with either system and is compatible with both Ultrasonic and Minitor functions. By ordering a second foot switch, you can provide hands-free stroke/power adjustment for two operators.

Ultraform Tooling

Tooling Accessories in this item are for use with Ultraform Models UF-2600, and UF-5600.

Usage of Tools

- All Ultraform tools are made to match the resonant frequency of Argofile UL-501B and Ultraform models 2100/3000/5000/2600/5600.
The manufacturer does not accept any liability for other manufacturers' tools.
- For maximum power, ensure all tools are securely fastened to the ultrasonic handpiece. Any noise coming from the joint between the tool and handpiece indicates an insecure fitting and/or bent tools, which result in reduced cutting power.
- Abrasive Stones/Ceramic Stones –
Ultraform models 2100/3000/5000: When using SX, LX champ horns ensure power output does not exceed 3 on power indicator scale. Above this power level excessive heat will cause the bonding of the abrasive stone to break down.
Ultraform models 2600/5600: Operate only with clamp horn mode switch.
- Wooden Laps –
Ultraform models 2100/3000/5000: When using wooden laps with SX, LX clamp horns ensure power output does not exceed 3 on power indicator scale. Above this power level excessive heat build-up will cause the wood to burn.
To obtain maximum driving power, retighten cap-screw on clamp horn during use.
Ultraform models 2600/5600: Operate only with clamp horn mode switch.

Color Coding

- All Ultraform diamond tools are color coded to identify the mesh/grit/micron (/UM) according to the chart below.

Color	MESH/GRIT	MICRON/UM
RED	200	68
BLACK	320	40
BLUE	500	35
WHITE	600	28
GREEN	1000	15

QUANTITY DISCOUNTS:

Discounts apply to current Net Prices. Applies to tooling on pages 23 thru 28 only. Tools of different styles and sizes may be combined on one order for quantity discounts.

1 to 5 Less 10%
6 or more Less 15%

Ultraform Diamond Files

- Diamond particles are electro-deposited on steel shank
- Used for intermediate finishing
- Fast cutting

Precision graded particle size (68-28 micron).
Excellent for finishing slot sidewalls and flat or curved surfaces.

NOTE: All measurements in millimeters (mm).

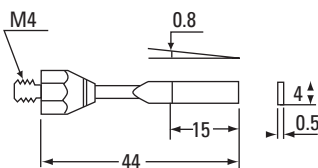

ITEM NUMBER	MESH/GRIT
USE-5845	200
USE-5745	320
USE-5545	600

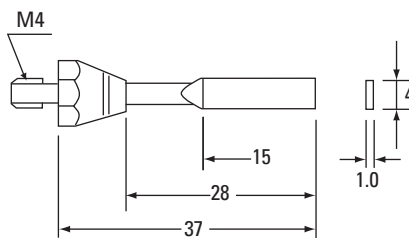

ITEM NUMBER	MESH/GRIT
SE-4841	200
SE-4741	320
SE-4541	600

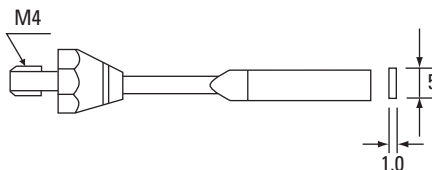

ITEM NUMBER	MESH/GRIT
SE-8851U	200
SE-8751U	320
SE-8551U	600

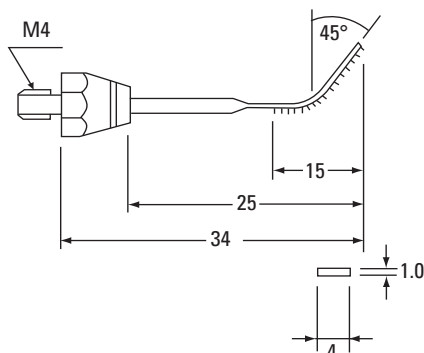

ITEM NUMBER	MESH/GRIT
SE-7841	200
SE-7741	320
SE-7541	600

Ultraform Diamond Files

NOTE: All measurements in millimeters (mm).

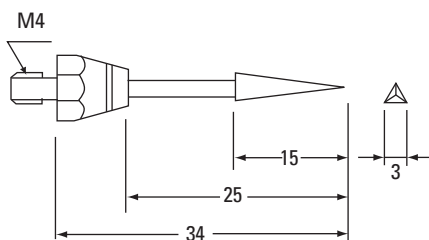

ITEM NUMBER	MESH/GRIT
SE-3803	200
SE-3703	320
SE-3503	600

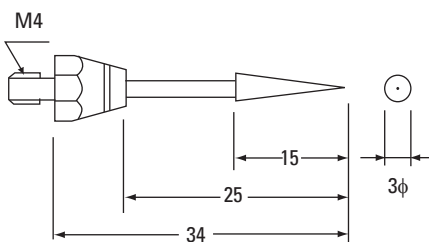

ITEM NUMBER	MESH/GRIT
SE-6803	200
SE-6703	320
SE-6503	600

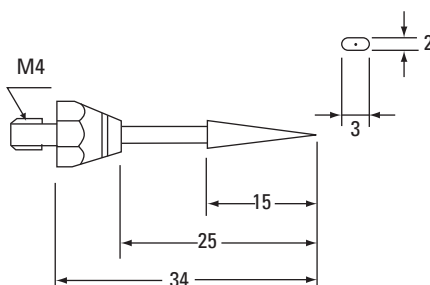

ITEM NUMBER	MESH/GRIT
SE-5832	200
SE-5732	320
SE-5532	600

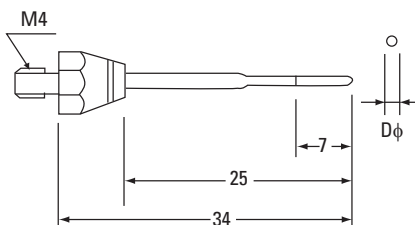

ITEM NUMBER	MESH/GRIT	D Ø
SE-9801	200	1mm
SE-9701	320	1mm
SE-9501	600	1mm
SE-9802	200	2mm
SE-9702	320	2mm
SE-9502	600	2mm

Ultraform Diamond Files | Resin Bonded Diamond Stones

NOTE: All measurements in millimeters (mm).

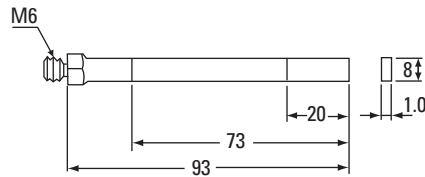

ITEM NUMBER	MESH/GRIT
UME-9881	200
UME-9781	320
UME-9581	600

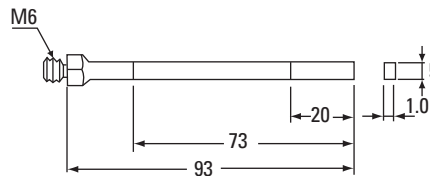

ITEM NUMBER	MESH/GRIT
UME-9851	200
UME-9751	320
UME-9551	600

Resin Bonded Diamond Stones

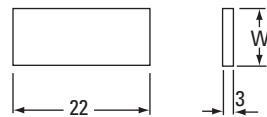

- Can be used on the ED surface
- 6W stones with tool clamp UMX-4030
- 10 stones with tool clamp UMX-4130

ITEM NUMBER	MESH/GRIT
UMD-4872	200
UMD-4772	320
UMD-4672	500
UMD-4372	1000
UMD-4812	200
UMD-4712	320
UMD-4612	500
UMD-4312	1000

Ultraform Diamond Stones

- Solid stone of diamond particles in a metal bond
- Used for intermediate and fine finishing
- Precision graded particle size (68 ~ 15 micron)
- Can be shaped with a diamond file to finish intricate surfaces

NOTE: All measurements in millimeters (mm).

COLOR CODING: Red... #200, Black...#320, Blue...#500, Green...#1000

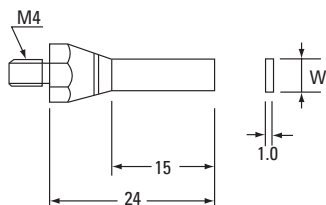

ITEM NUMBER	MESH/GRIT	W
SD-4831	200	3.0
SD-4731	320	3.0
SD-4631	500	3.0
SD-4331	1000	3.0
SD-4851	200	5.0
SD-4751	320	5.0
SD-4651	500	5.0
SD-4351	1000	5.0

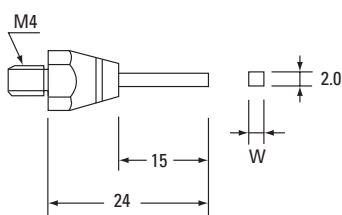

ITEM NUMBER	MESH/GRIT	W
SD-2802	200	2.0
SD-2702	320	2.0
SD-2602	500	2.0
SD-2302	1000	2.0
SD-4832	200	3.0
SD-4732	320	3.0
SD-4632	500	3.0
SD-4332	1000	3.0

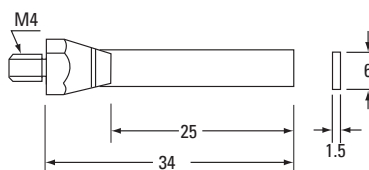

ITEM NUMBER	MESH/GRIT
SD-4862	200
SD-4762	320
SD-4662	500
SD-4362	1000

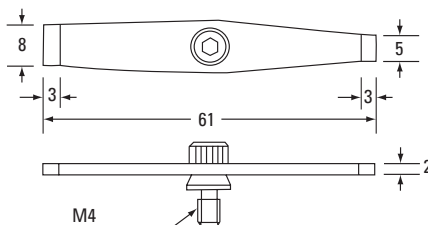

ITEM NUMBER	MESH/GRIT
USD-7885	200
USD-7785	320
USD-7685	500
USD-7385	1000

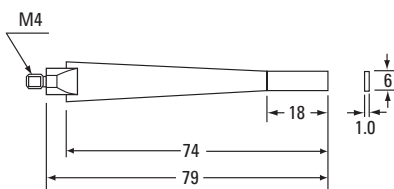

ITEM NUMBER	MESH/GRIT
USD-5861	200
USD-5761	320
USD-5661	500
USD-5361	1000

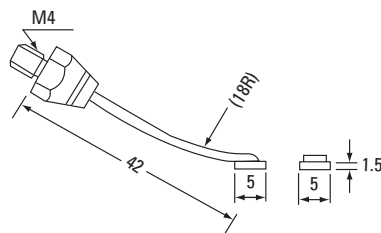

ITEM NUMBER	MESH/GRIT
SD-7855	200
SD-7755	320
SD-7655	500
SD-7355	1000

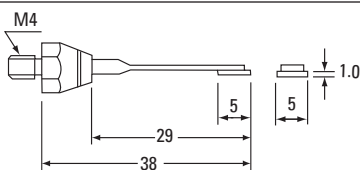

ITEM NUMBER	MESH/GRIT
SD-4861	200
SD-4761	320
SD-4661	500
SD-4361	1000

Ultraform Diamond Stones

NOTE: All measurements in millimeters (mm).

COLOR CODING: Red...#200, Black...#320, Blue...#500, Green...#1000

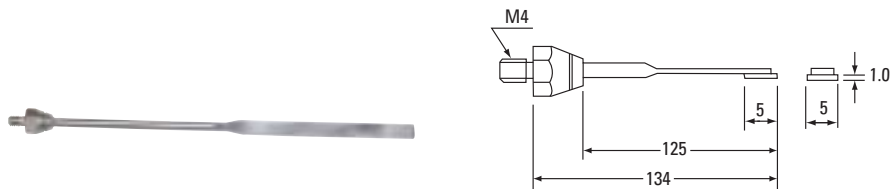

ITEM NUMBER	MESH/GRIT
SD-8851	200
SD-8751	320
SD-8651	500
SD-8351	1000

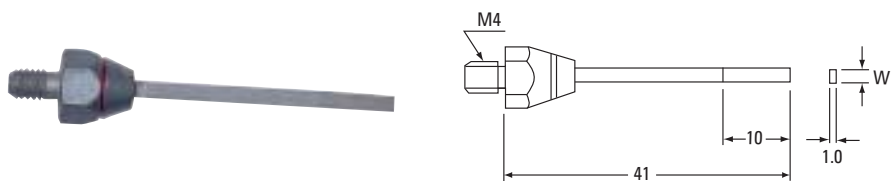

ITEM NUMBER	MESH/GRIT	W
SD-5821	200	2.0
SD-5721	320	2.0
SD-5621	500	2.0
SD-5321	1000	2.0
SD-5831	200	3.0
SD-5731	320	3.0
SD-5631	500	3.0
SD-5331	1000	3.0

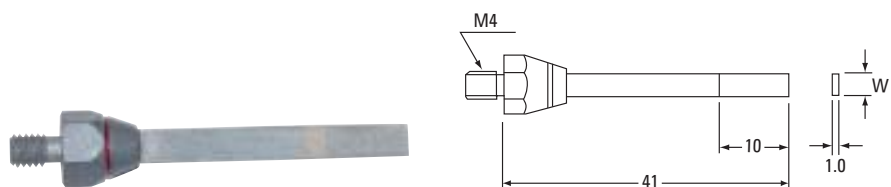

ITEM NUMBER	MESH/GRIT	W
SD-5841	200	4.0
SD-5741	320	4.0
SD-5641	500	4.0
SD-5341	1000	4.0
SD-5851	200	5.0
SD-5751	320	5.0
SD-5651	500	5.0
SD-5351	1000	5.0

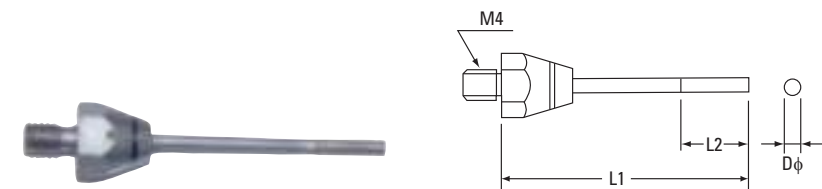

ITEM NUMBER	MESH/GRIT	L1	L2	D
SD-1802	200	37	7.0	2.0
SD-1702	320	37	7.0	2.0
SD-1602	500	37	7.0	2.0
SD-1302	1000	37	7.0	2.0
SD-1803	200	39	10	3.0
SD-1703	320	39	10	3.0
SD-1603	500	39	10	3.0
SD-1303	1000	39	10	3.0



ITEM NUMBER	MESH/GRIT
UMD-8862	200
UMD-8762	320
UMD-8662	500
UMD-8362	1000

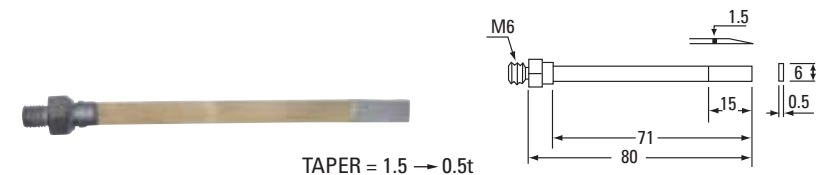

ITEM NUMBER	MESH/GRIT
UMD-9865	200
UMD-9765	320
UMD-9665	500
UMD-9365	1000



ITEM NUMBER	MESH/GRIT
UMD-1825	200
UMD-1725	320
UMD-1625	500
UMD-1325	1000

Ultraform Ruby Stones

- Precision graded particle size (17 micron)
- Can be shaped with a diamond file or stone to finish intricate surfaces
- Designed for fine finishing
- Fast cutting on soft surfaces
- Ideal for fine detail work and squaring off rounded corners

NOTE: All measurements in millimeters (mm).

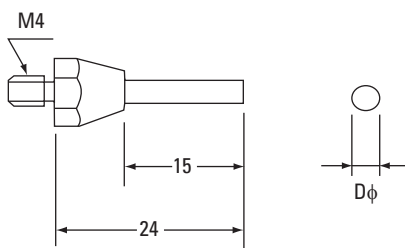

ITEM NUMBER	D
SR-1402	2.0
SR-1403	3.0

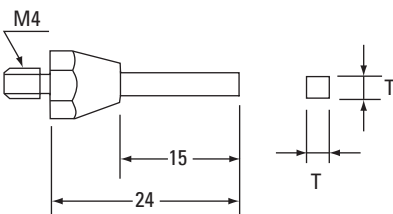

ITEM NUMBER	D
SR-2402	2.0
SR-2403	3.0

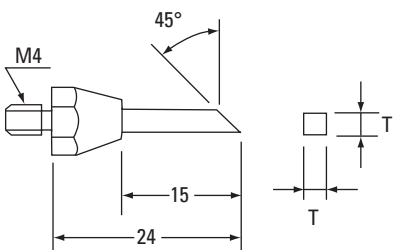

ITEM NUMBER	T
SR-7402	2.0
SR-7403	3.0

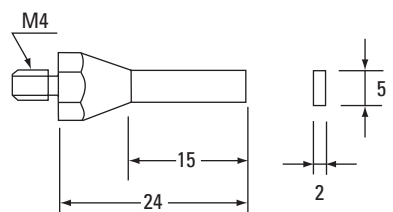

ITEM NUMBER	T
SR-4451	1.0
SR-4452	2.0

Ultraform Ceramic Stones

- Completely new line of abrasive stones made from a plastic matrix reinforced with high performance cutting ceramic fibers
- When used with ultrasonic vibration (ULTRAFORM) an exceptional polishing/cutting action is obtained
- Non-brittle stone ideal for polishing aluminum, stainless steel and tool steel
- Very durable with a long life and, when shaped, hold their profile without having to be reshaped

*Color Code/Mesh

COLOR	MESH/GRIT
BROWN	600
BLUE	800
WHITE	1000
RED	1200

NOTE: All measurements in millimeters (mm).

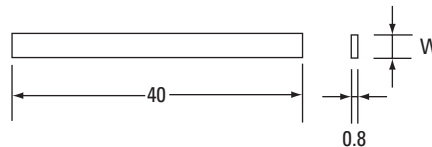

ITEM NUMBER	COLOR* CODE	W
USC-4548	BROWN	4
USC-4448	BLUE	4
USC-4348	WHITE	4
USC-4248	RED	4
USC-4568	BROWN	6
USC-4468	BLUE	6
USC-4368	WHITE	6
USC-4268	RED	6

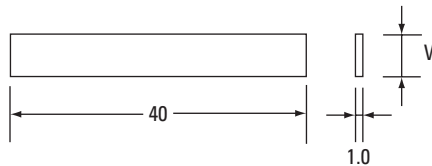

ITEM NUMBER	COLOR* CODE	W
USC-4541	BROWN	4
USC-4441	BLUE	4
USC-4341	WHITE	4
USC-4241	RED	4
USC-4561	BROWN	6
USC-4461	BLUE	6
USC-4361	WHITE	6
USC-4261	RED	6

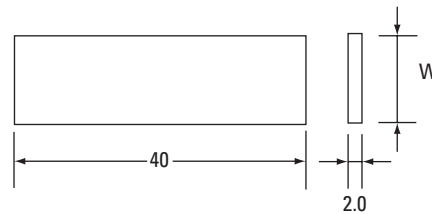

ITEM NUMBER	COLOR* CODE	W
ULC-4562	BROWN	6
ULC-4462	BLUE	6
ULC-4362	WHITE	6
ULC-4262	RED	6
ULC-4512	BROWN	12
ULC-4412	BLUE	12
ULC-4312	WHITE	12
ULC-4212	RED	12

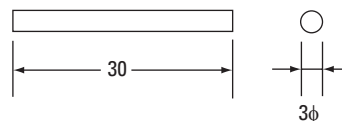

ITEM NUMBER	COLOR* CODE
USC-1530	BROWN
USC-1430	BLUE
USC-1330	WHITE
USC-1230	RED

Ultraform Abrasive Stones | Lapping Tools

- Non-loading, resin bonded
- Precision graded particle size (150-600 grit)
- Fast cutting
- For rough and intermediate finishing
- Can be shaped with diamond file to suit surface contours

NOTE: All measurements in millimeters (mm).

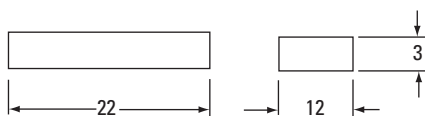

ITEM NUMBER	MESH/GRIT
LG-4813	150
LG-4713	220
LG-4613	280
LG-4513	320
LG-4413	400
LG-4313	600

Lapping Tools

- For fine and ultra-fine polishing with diamond paste
- Can be shaped with a diamond file or stone to polish intricate surfaces

NOTE: All measurements in millimeters (mm).

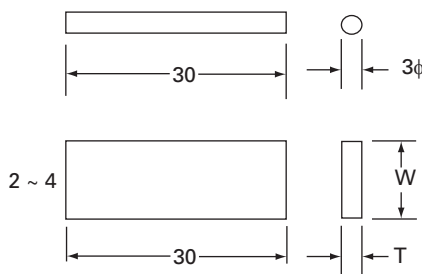

	ITEM NUMBER	W	T
1	SO-1103	—	—
2	SO-4163	6	3.2
3	LO-4013	15	3.2
4	LO-2005	5	5
5	LO-4015	15	5

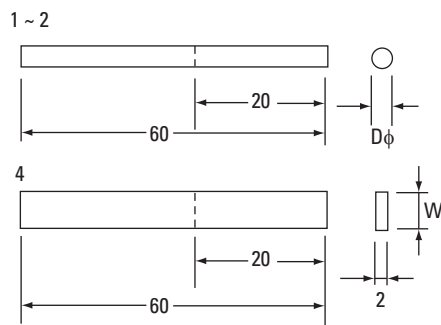

	ITEM NUMBER	D	W
1	SS-1102	2	—
2	SS-1103	3	—
4	LS-4082	—	8

Can be cut and shortened at / marked.

Ultraform Tool Clamps (Clamp Horns)

NOTE: All measurements in millimeters (mm).

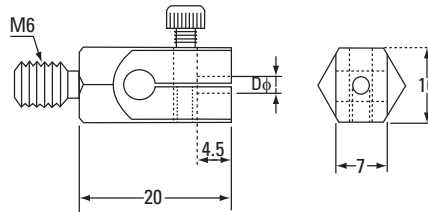

ITEM NUMBER	D
UMX-1020	2.0
UMX-1030	3.0
UMX-1033	3.3

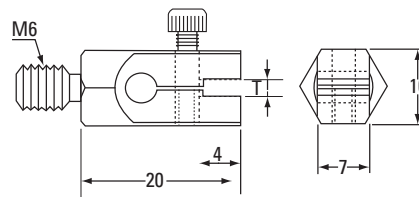

ITEM NUMBER	T
UMX-4008	0.8
UMX-4010	1.0
UMX-4020	2.0
UMX-4030	3.0
UMX-4033	3.3

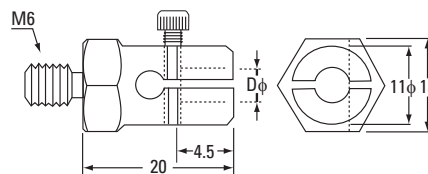

ITEM NUMBER	D
UMX-1140	4.0
UMX-1150	5.0
UMX-1160	6.0

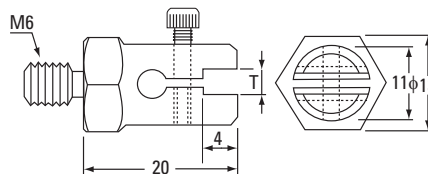

ITEM NUMBER	T
UMX-4110	1.0
UMX-4120	2.0
UMX-4130	3.0
UMX-4133	3.3
UMX-4140	4.0
UMX-4150	5.0

Ultraform Adapters

NOTE: All measurements in millimeters (mm).

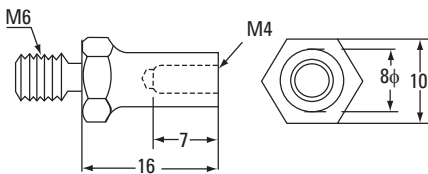

ITEM NUMBER
UMS-0064

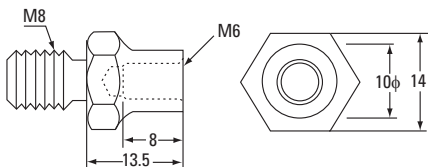

ITEM NUMBER
UMS-0086

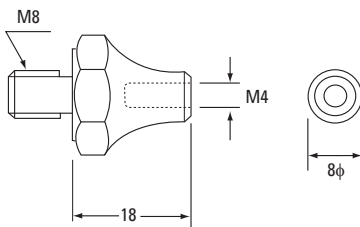

ITEM NUMBER
SL-1000

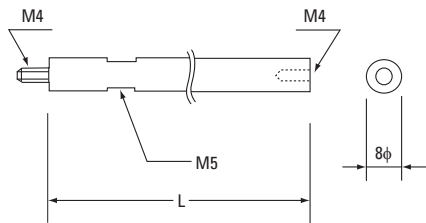
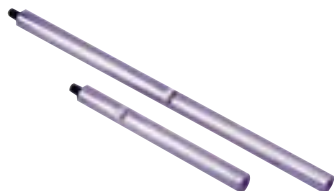

ITEM NUMBER	L
SL-1080	80
SL-1160	160

Ultraform Accessories

ULTRAFORM ACCESSORIES

HANDPIECE
UF-9700

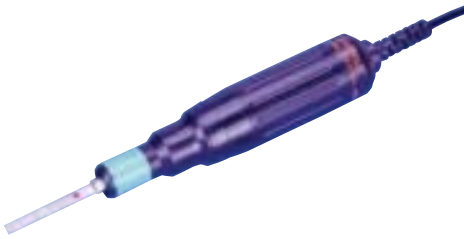

FOOT SWITCH
UF-7503 (VARIABLE CONTROL)



CLAMP HORN KEY
UF-7005 M4



PROTECTION SLEEVE
1) UF-7024
2) UF-7026
3) UF-7025



**SPECIAL
ORDER ONLY**

WOODEN CASE FOR HANDPIECE
UF-7017 for UF-9000, UF-9700



PLASTIC TOOL BOX
UF-7022



POWER CORD
UF-7100 100V Korea
UF-7101 115V U.S.A.
UF-7102 220V Europe
UF-7103 240V U.K.

